

## FAQ

**Q** What heater should I choose?

**A** Leave it to us!  
We will listen to your needs and suggest the most suitable heater.

**Q** Can we meet on-site?

**A** Of course, we will accompany you.  
We can visit anywhere in Japan.

**Q** I'm having a problem right now,  
what is the delivery time?

**A** We have heaters that can be shipped on the same day.  
If you order by 3PM, we will ship the same day.

**Q** Can I order just one heater?

**A** Yes, we accept orders for standard and made-to-order products, starting from just one piece.

**Q** Do you have samples?

**A** Yes, we do.  
Please contact us regarding types.

# 熱

Let us resolve your heating problems.

 **THREE HIGH**  
CO.,LTD. SINCE 1990

Web: [www.threehigh.com](http://www.threehigh.com)  
Mail: [info\\_overseas@threehigh.co.jp](mailto:info_overseas@threehigh.co.jp)



Headquarters/Factory 4-42-16 Higashiyamata, Tsuzuki Ward, Yokohama City, Kanagawa 224-0023 JAPAN  
TEL: +81-45-590-5561 FAX: +81-45-590-5571

 **THREE HIGH**  
CO.,LTD. SINCE 1990

Prevents freezing

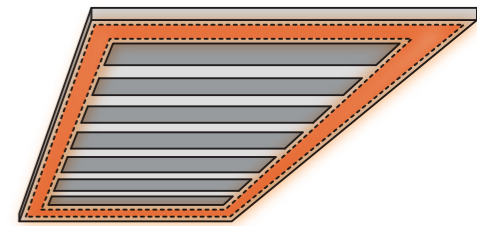
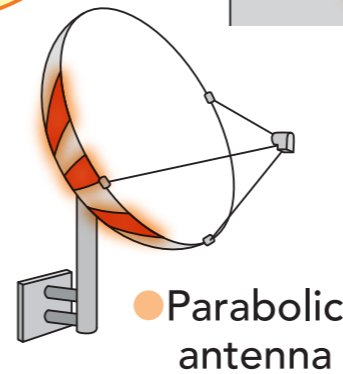
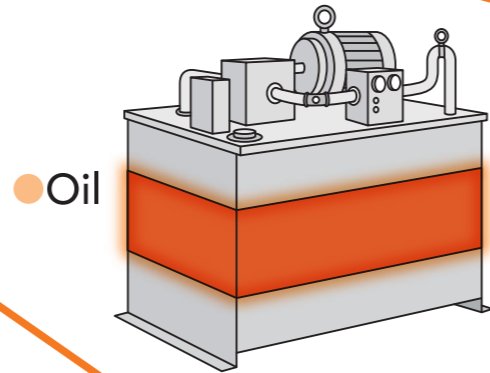
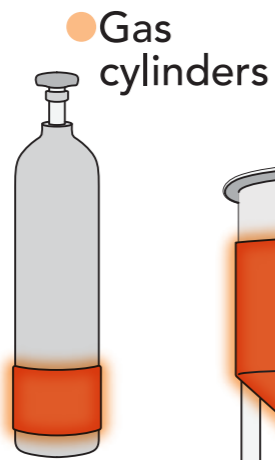
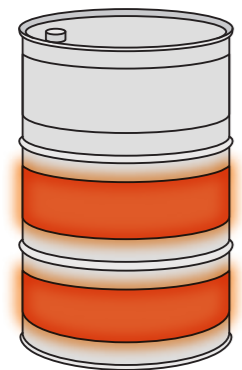
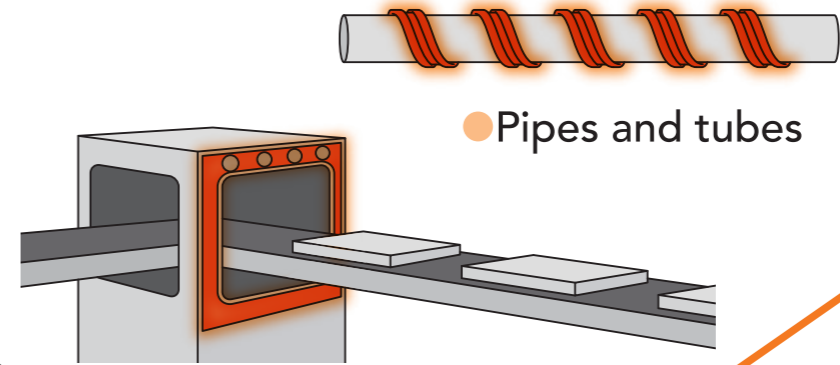
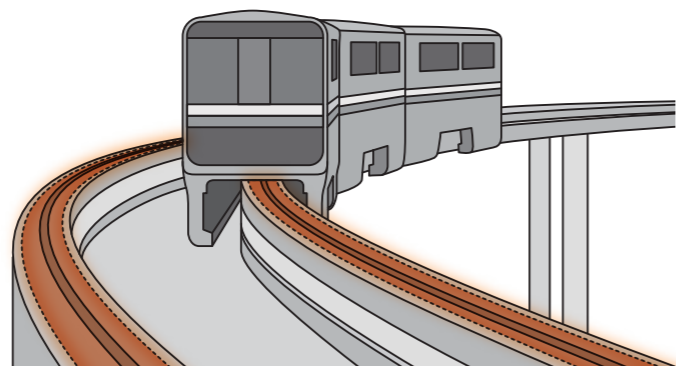

Insulation

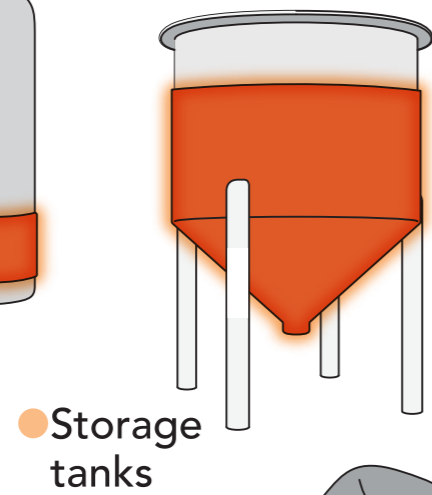

# Heaters

Used in all places, out of sight

Anti-fog

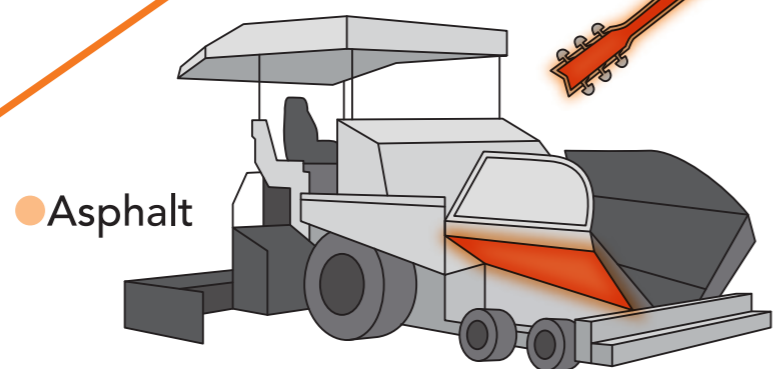
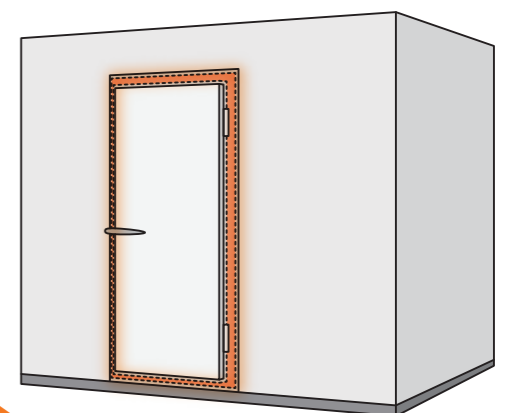
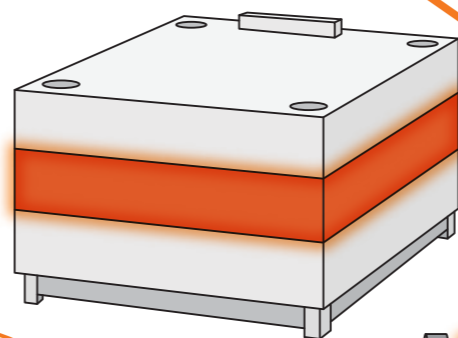
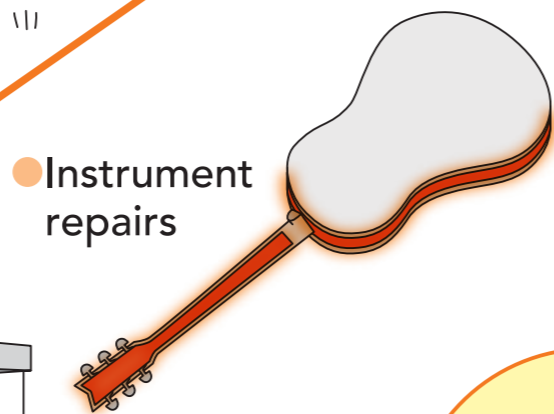
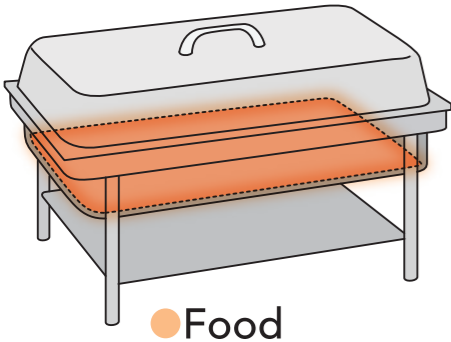
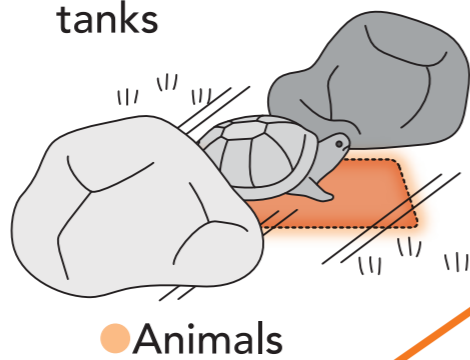

Pre-heat

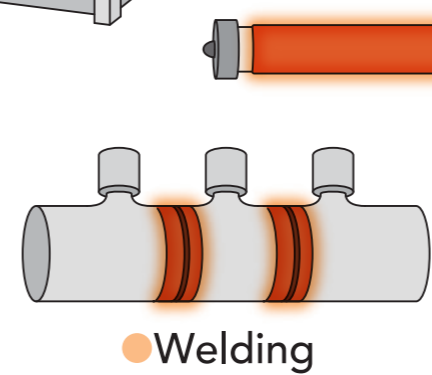

## What temperature does it go up to?

Heater temperature varies depending on capacity, operating environment, and other factors. Please contact us for details.

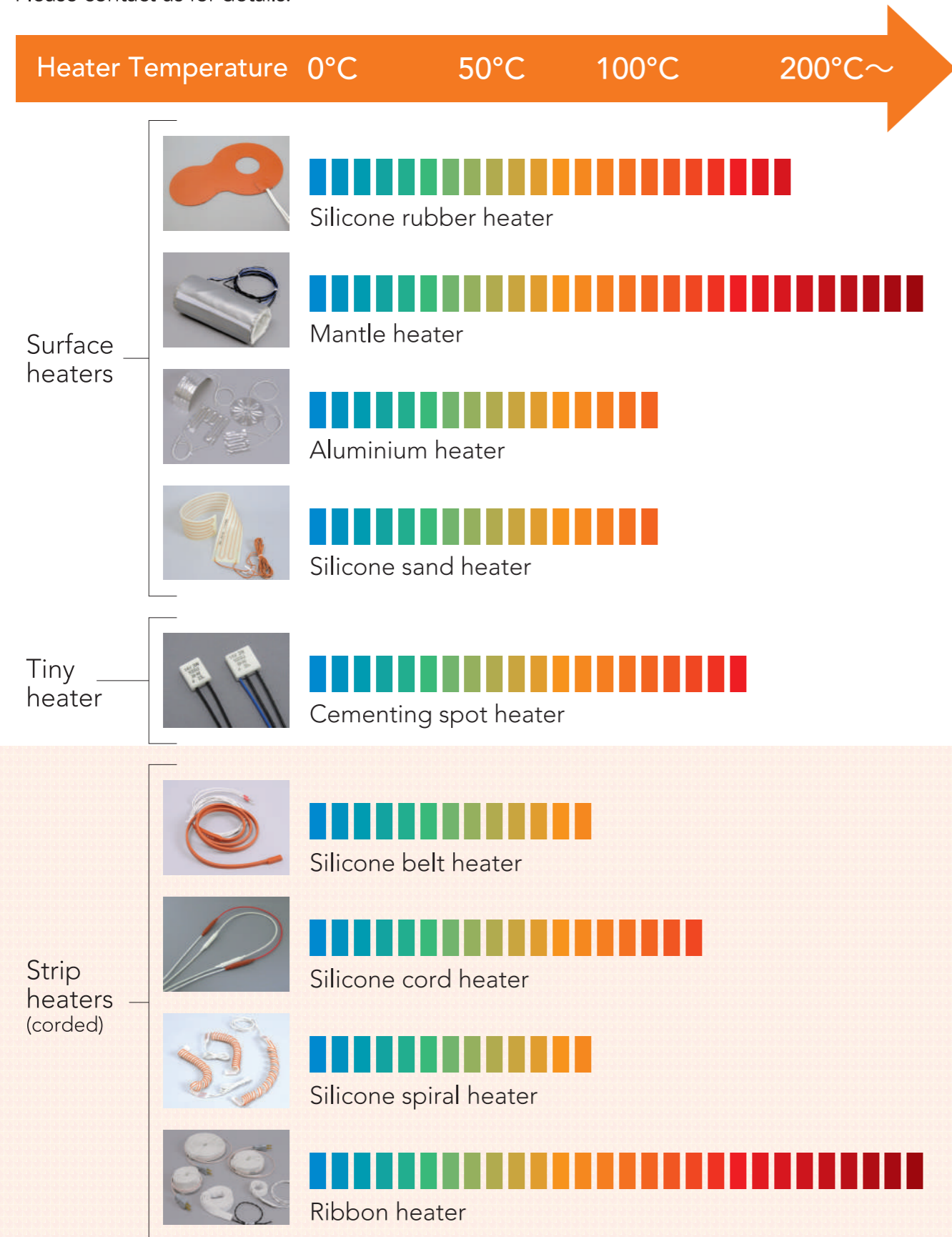

## What to prepare and how to use?

### Case 1

For hopper tanks (funnel Shape)  
Warming · Insulation heater

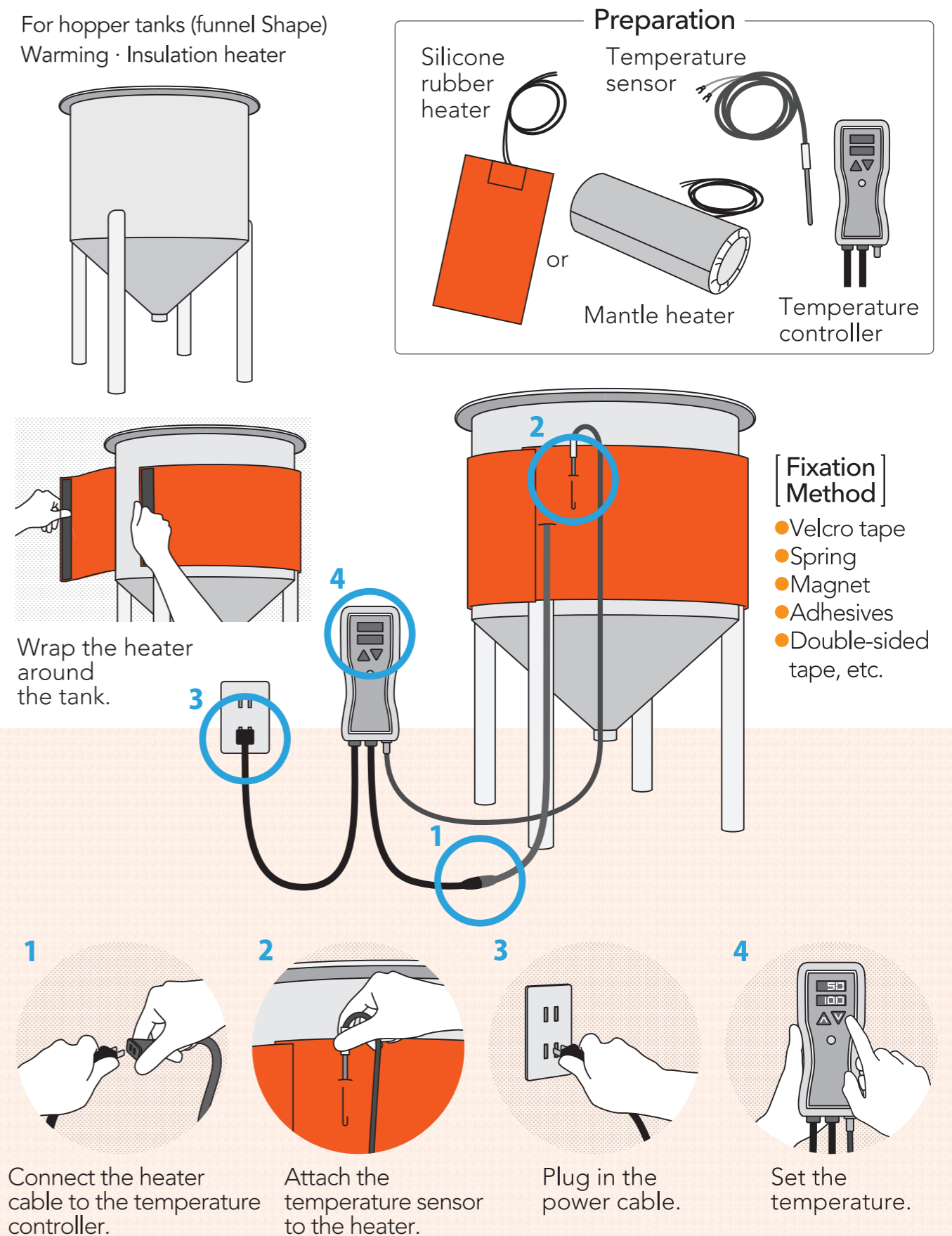

# What to prepare and how to use?

## Case 2

### Freeze preventing pipe heater

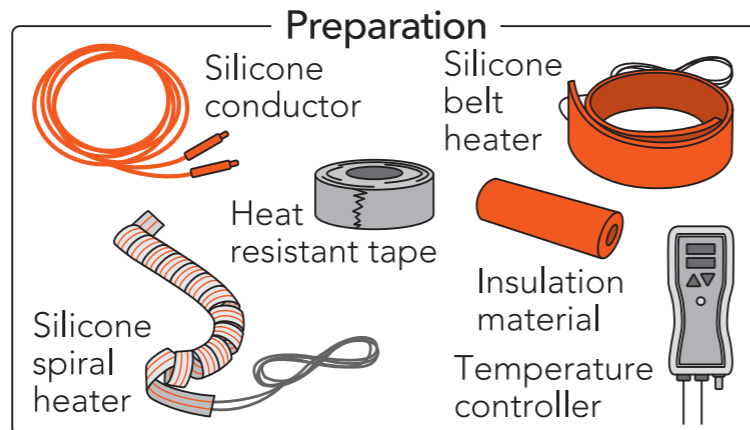
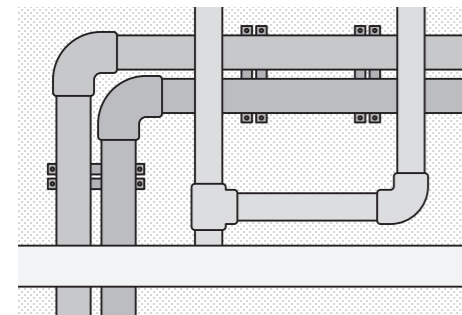

① Wrap the heater around the piping

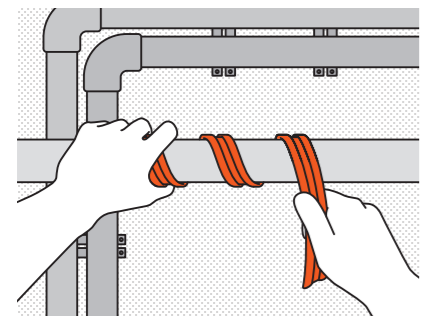

Silicone belt heater · Cord heater, etc.

② Fixed with heat resistant tape

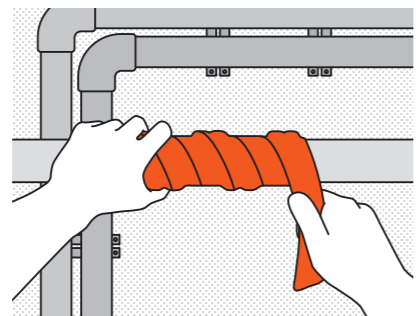

Silicone tape · Aluminum foil tape, etc.

③ Insulation to retain heat

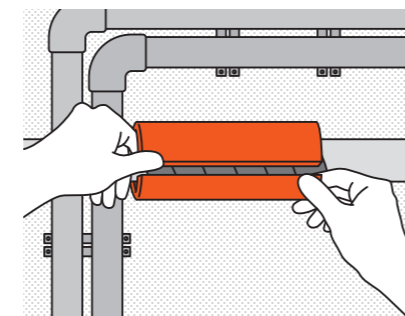

Silicone Sponge · Glass wool, etc.

## Case 3

### Snow-melt · Anti-fog & condense

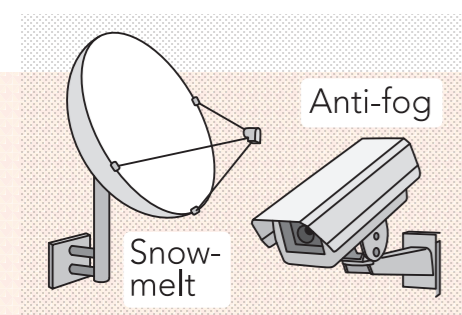

Parabolic antenna · Snow-melting

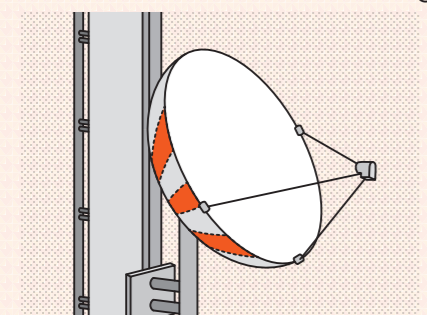

Heater attached to back of the antenna to melt snow.

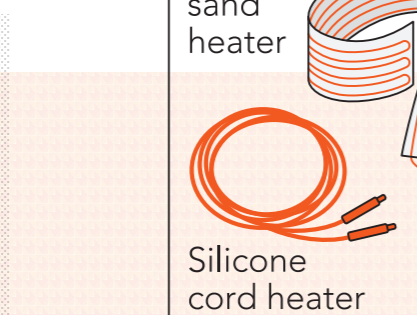

Camera lens · Anti-fog

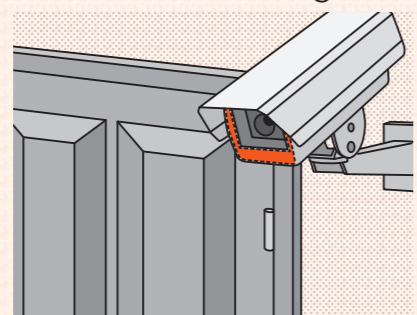

Paste the heater around the lens, to prevent the lens from moving.

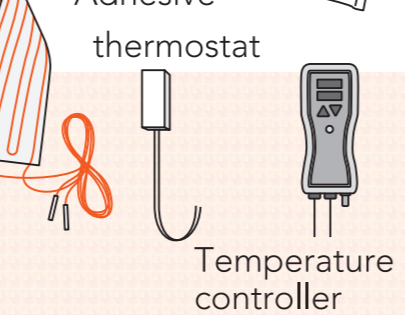

Air conditioning · Prevents condensation

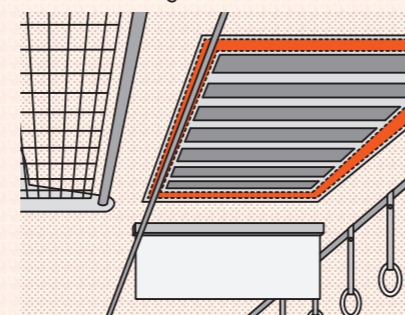

Heater installed near the air conditioner outlet to prevent condensation.

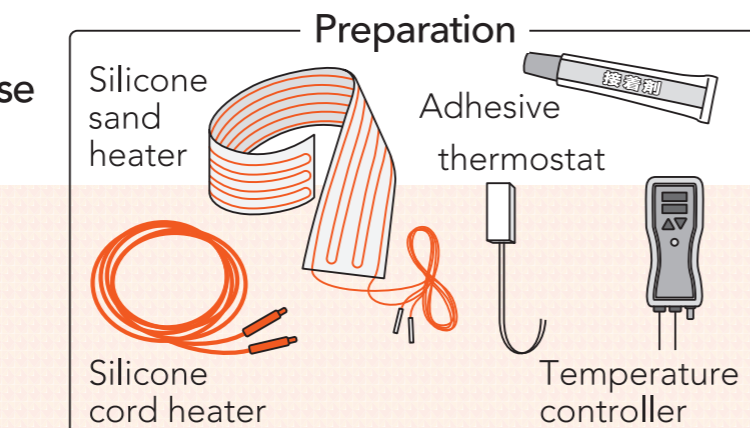

## Flow from inquiry to heater production

There are three main ways to make a request.

First, we will ask you about the purpose of the heater, and the shape and size of the object to be heated.

① Drawings

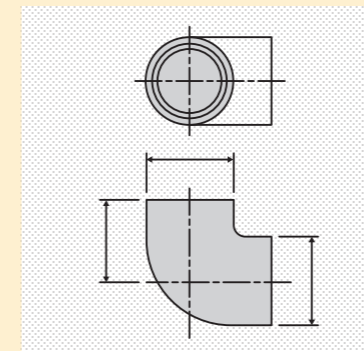

② Visit to take measurements

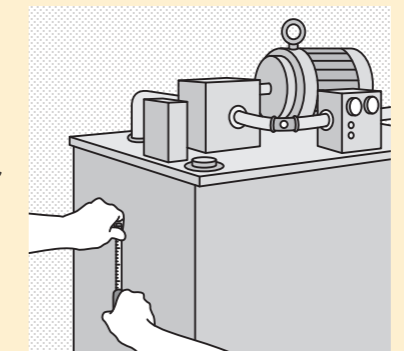

③ Supplied item

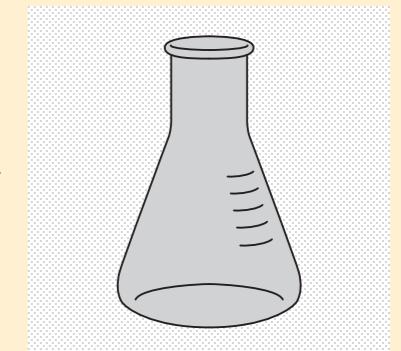

Meeting

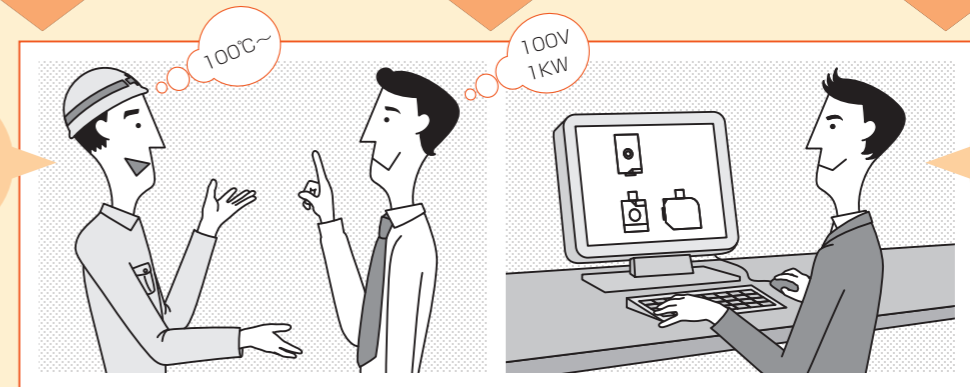

Design

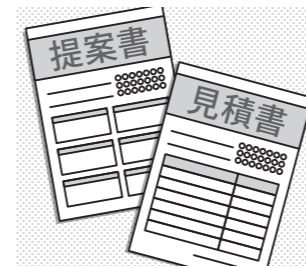

Proposal · Estimate



Order

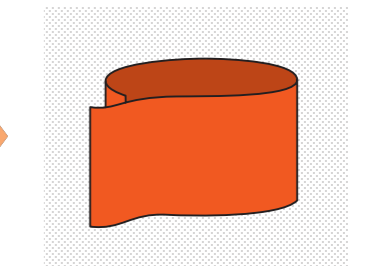

Production

